

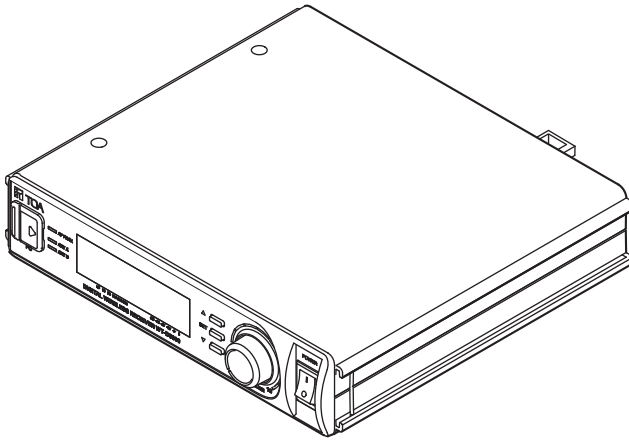

CE
INSTRUCTION MANUAL

DIGITAL WIRELESS RECEIVER

WT-D5800



Thank you for purchasing TOA's Digital Wireless Receiver.
Please carefully follow the instructions in this manual to ensure long, trouble-free use of your equipment.

TABLE OF CONTENTS

1. SAFETY PRECAUTIONS	3
2. GENERAL DESCRIPTION	5
3. FEATURES	5
4. HANDLING PRECAUTIONS	5
5. NOMENCLATURE AND FUNCTIONS	6
Front	6
Rear	7
6. RACK MOUNTING	8
7.1. Example 1	9
7.2. Example 2	9
7.3. Contact Output Settings	10
8. FUNCTION SETTINGS	11
8.1. Placing the Unit in Setting Mode	11
8.2. Setting Items Displayed on the LCD Screen in Setting Mode	11
8.3. Function Settings	12
9. OPERATION	23
10. HOW TO CHECK AND DEAL WITH INTERFERENCE	24
11. SPECIFICATIONS	26
Accessories	26
Optional products	26

1. SAFETY PRECAUTIONS

- Before installation or use, be sure to carefully read all the instructions in this section for correct and safe operation.
- Be sure to follow all the precautionary instructions in this section, which contain important warnings and/or cautions regarding safety.
- After reading, keep this manual handy for future reference.



WARNING

Indicates a potentially hazardous situation which, if mishandled, could result in death or serious personal injury.

power, disconnect the power supply plug from the AC outlet and contact your nearest TOA dealer. Make no further attempt to operate the unit in this condition as this may cause fire or electric shock.

- If you detect smoke or a strange smell coming from the unit
- If water or any metallic object gets into the unit
- If the unit falls, or the unit case breaks
- If the power supply cord is damaged (exposure of the core, disconnection, etc.)
- If it is malfunctioning (no tone sounds)
- If it is malfunctioning (no LCD indication appears)

- To prevent a fire or electric shock, never open nor remove the unit case as there are high voltage components inside the unit. Refer all servicing to qualified service personnel.

- Do not place cups, bowls, or other containers of liquid or metallic objects on top of the unit. If they accidentally spill into the unit, this may cause a fire or electric shock.

- Do not insert nor drop metallic objects or flammable materials in the ventilation slots of the unit's cover, as this may result in fire or electric shock.

- Do not touch a power supply plug or antenna during thunder and lightning, as this may result in electric shock.

- To prevent the electromagnetic wave from badly influencing medical equipment, make sure to switch off the unit's power when placing it in close proximity to the medical equipment.

When Installing the Unit

- Do not expose the unit to rain or an environment where it may be splashed by water or other liquids, as doing so may result in fire or electric shock.
- Use the unit only with the voltage specified on the unit. Using a voltage higher than that which is specified may result in fire or electric shock.
- Do not cut, kink, otherwise damage nor modify the power supply cord. In addition, avoid using the power cord in close proximity to heaters, and never place heavy objects -- including the unit itself -- on the power cord, as doing so may result in fire or electric shock.
- Avoid installing or mounting the unit in unstable locations, such as on a rickety table or a slanted surface. Doing so may result in the unit falling down and causing personal injury and/or property damage.
- Since the unit is designed for indoor use, do not install it outdoors. If installed outdoors, the aging of parts causes the unit to fall off, resulting in personal injury. Also, when it gets wet with rain, there is a danger of electric shock.

When the Unit is in Use

- Should the following irregularity be found during use, immediately switch off the

CAUTION

Indicates a potentially hazardous situation which, if mishandled, could result in moderate or minor personal injury, and/or property damage.

When Installing the Unit

- Never plug in nor remove the power supply plug with wet hands, as doing so may cause electric shock.
- When unplugging the power supply cord, be sure to grasp the power supply plug; never pull on the cord itself. Operating the unit with a damaged power supply cord may cause a fire or electric shock.
- When moving the unit, be sure to remove its power supply cord from the wall outlet. Moving the unit with the power cord connected to the outlet may cause damage to the power cord, resulting in fire or electric shock. When removing the power cord, be sure to hold its plug to pull.
- Avoid installing the unit in humid or dusty locations, in locations exposed to the direct sunlight, near the heaters, or in locations generating sooty smoke or steam as doing otherwise may result in fire or electric shock.
- Be sure to follow the instructions below when rack-mounting the unit. Failure to do so may cause a fire or personal injury.
 - Install the equipment rack on a stable, hard floor. Fix it with anchor bolts or take other arrangements to prevent it from falling down.
 - When connecting the unit's power cord to an AC outlet, use the AC outlet with current capacity allowable to the unit.

When the Unit is in Use

- Make sure that the volume control is set to minimum position before power is switched

on. Loud noise produced at high volume when power is switched on can impair hearing.

- Do not operate the unit for an extended period of time with the sound distorting. Doing so may cause the connected speakers to heat, resulting in a fire.
- Use the dedicated AC adapter for the unit. Note that the use of other adapter may cause a fire.
- Contact your TOA dealer as to the cleaning. If dust is allowed to accumulate in the unit over a long period of time, a fire or damage to the unit may result.
- If dust accumulates on the power supply plug or in the wall AC outlet, a fire may result. Clean it periodically. In addition, insert the plug in the wall outlet securely.
- Switch off the power, and unplug the power supply plug from the AC outlet for safety purposes when cleaning or leaving the unit unused for 10 days or more. Doing otherwise may cause a fire or electric shock.
- Any modifications made to this device that are not approved by TOA Corporation may void the authority granted to the user to operate this equipment.

2. GENERAL DESCRIPTION

The WT-D5800 is a digital wireless receiver that employs the PLL synthesizer communication method.

Use this receiver in combination with TOA's WM-D5200 or WM-D5300 digital wireless microphone.

3. FEATURES

- The digital true diversity method minimizes radio interference and noise, ensuring stable radio wave reception.
- TOA's unique digital audio signal processing technology eliminates sound quality deterioration common to analog systems.
- Digital transmission and encryption settings reduce the chance of transmitted information being leaked outside the area of use.
- Systems using the same channel can be installed closer to each other than possible with analog systems.
- The remaining battery capacity of the wireless microphone can be checked by way of data transmission using a PC.
- Idle channels can be displayed by way of channel scanning.
- A contact output terminal is provided for control of external equipment.
- Feedback suppressor automatically suppresses acoustic feedback.
- Connecting the unit to a PC allows the reception status to be monitored using the WT-D5800 Maintenance Software*, which is useful for installation and maintenance.

* Download from the TOA website (<http://www.toa-products.com/international/>).

4. HANDLING PRECAUTIONS



- Make sure that the power switch is switched OFF after use.
- When mounting in an equipment rack, select the position which does not expose the unit to high temperature.
- When installing, keep the unit as far away as possible from fluorescent lamps, digital equipment, personal computers, and other equipment which generate high frequency noise.
- Only the same bank wireless systems can be used in the same location. Avoid using the systems in combination with those of different banks because interference or noise could be generated.
- Wireless receivers to be installed in the same location must differ from each other in channel number. Setting them for the same channel number could result in noise. Wireless microphones must be identical to wireless receivers in both bank and channel numbers.
- When using two or more wireless microphones, keep them at least 50 cm away from each other to avoid malfunctions or noise.
- Keep the wireless microphone at least 3 m away from the receiving antenna. Using the microphone in close proximity to the antenna could result in malfunctions or noise.
- Be sure to connect at least two receiving antennas (one each for Channels A and B).

5. NOMENCLATURE AND FUNCTIONS

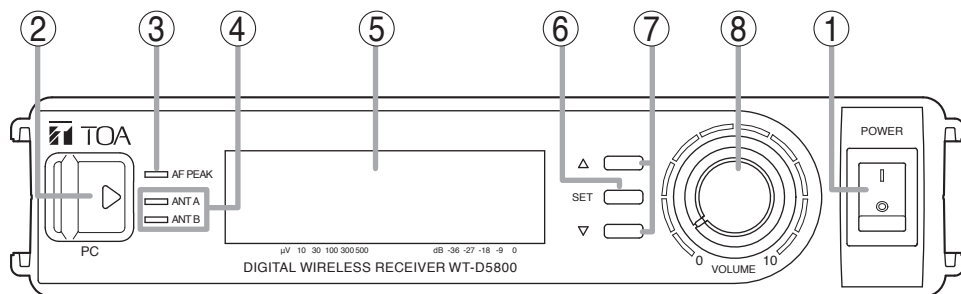
[Front]



1. Power switch

Pushing this switch to the ON position () turns the power ON, while pushing it to the OFF position () turns the power OFF.

2. USB connector for PC use

Used to connect the unit to a PC with the installed software.

3. AF peak indicator

Lights when the output level reaches the point of about 3 dB below the clipping level.

4. Reception indicators

Depending on the state of reception, the indicator's lit or unlit state will be determined as follows.

When being received normally*1	Lit (green)
When abnormal reception occurs*2	Lit (red)
When reception does not occur	Unlit

*1 While receiving radio waves and when audio output is in a ready state

*2 While receiving radio waves, in the state when audio output does not occur

5. LCD screen

The status of each function is displayed, such as for reception frequency, security setting, and battery level, etc.

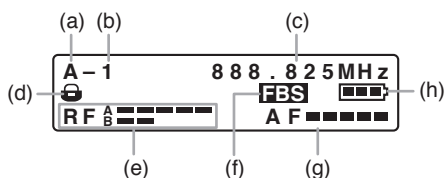

(a) Bank number

(b) Channel number

(c) Frequency

(d) Lock icon

Displayed when the Encryption function is enabled.

(e) RF meters A and B

Indicate the received radio wave strength in meters.

"A" indicates the strength of radio waves received by the 'A' system antenna, while "B" indicates the radio wave strength of the 'B' system antenna.

(f) FBS indication

Displayed when the FBS function is enabled.

(g) AF meter

Indicates the received microphone audio signal level in meters.

(h) Remaining battery capacity indicator

Indicates the microphone's remaining battery capacity.

 : Battery power is full charge.

 : Battery power depletion has started.

 : Battery power is almost depleted, and battery replacement is required.

6. Set key

Brings the unit in setting mode when pressed for about 1 second in normal operating state. In setting mode, pressing this key determines the selected setting item and registers its contents.

7. Up/Down keys

Select the setting items displayed on the LCD screen (5).
LCD screen (5).

8. Volume control

Adjusts an output level.

[Rear]

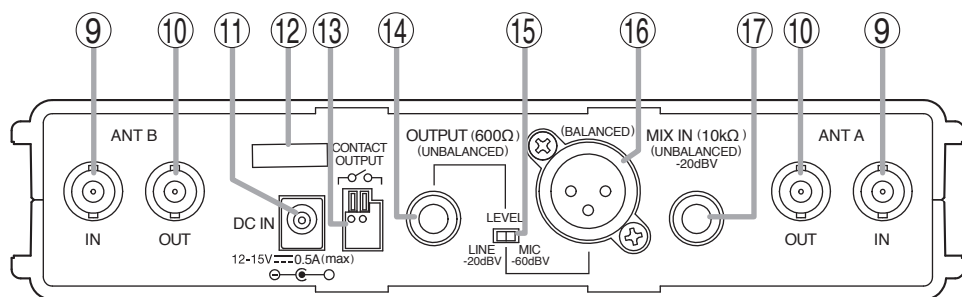

9. Antenna inputs A and B

75 Ω, BNC

For the wireless system covering a relatively narrow area, use the supplied two rod antennas, which should be set up at a 45° angle outwards from a vertical line.

13. Contact output terminal

Push-type terminal block

Depending on the state of the microphone, the make contact is output.

10. Antenna distribution outputs A and B

75 Ω, BNC

Output the same signals as those which are input to Antenna inputs A, B (9). Used for an RF cascade connection.

14. AF output

-20 dB*/-60 dB* selectable, unbalanced, phone jack.

15. AF output level selector

Sets the output level from the AF outputs by selecting either MIC (-60 dB*/600 Ω) or LINE (-20 dB*/600 Ω).

11. DC input jack

Connect the power cable of the supplied AC adapter or equivalent to this jack.

16. AF output

-20 dB*/-60 dB* selectable, balanced, XLR connector, male type (pin #2: Hot)

12. Cable hanger

Hook the power cable onto this part.

17. AF mixing input

-20 dB*, 10 kΩ, unbalanced, phone jack.
Connects to other unit's AF output.

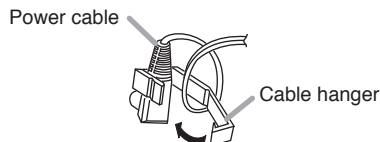

* 0 dB = 1 V

6. RACK MOUNTING

- When mounting one WT-D5800 unit, use an optional mounting kit MB-WT3.

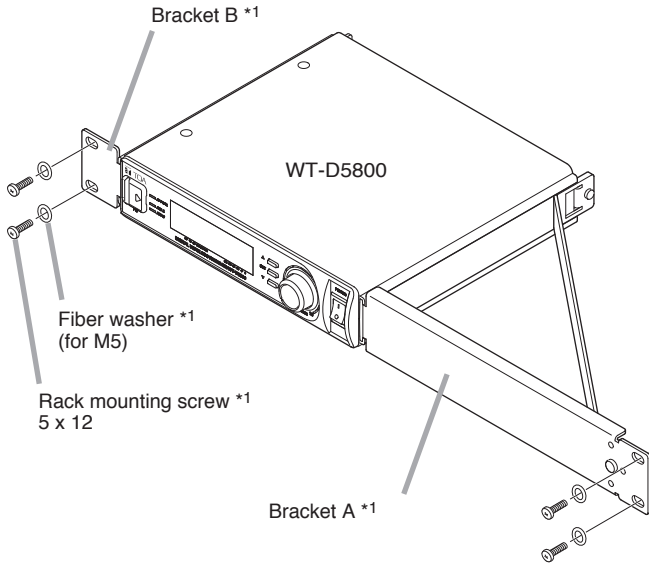

*1 Component parts of the MB-WT3.

- When mounting two WT-D5800 units, use an optional mounting kit MB-WT4.

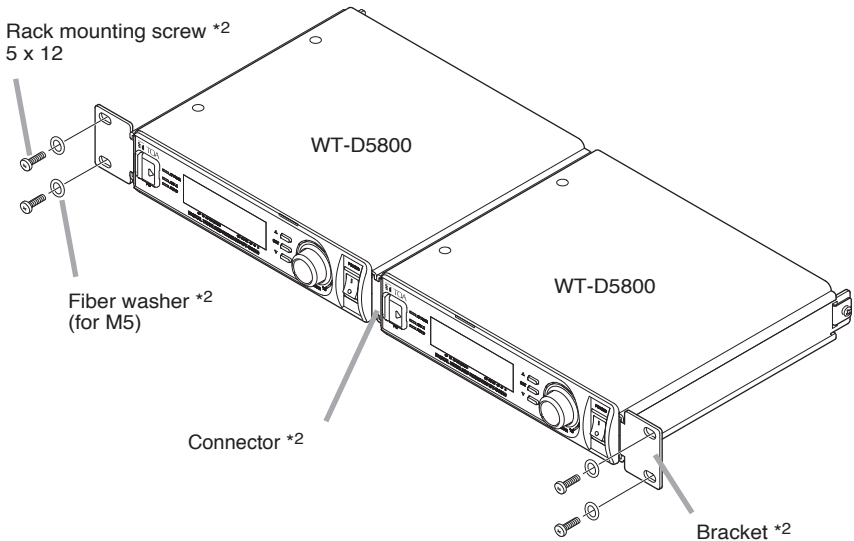

*2 Component parts of the MB-WT4.

7. CONNECTION EXAMPLES

Be sure to connect at least two receiving antennas (one each for Channels A and B).

7.1. Example 1

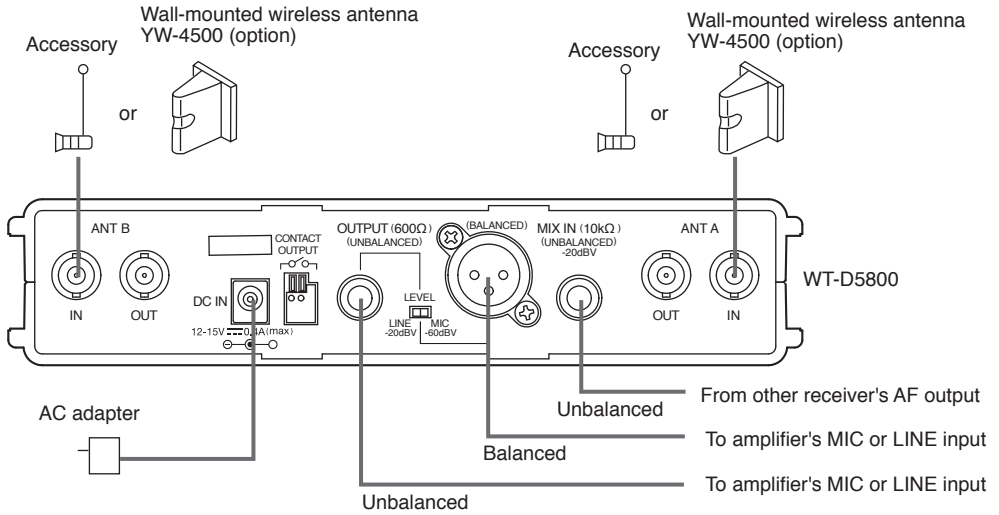

7.2. Example 2

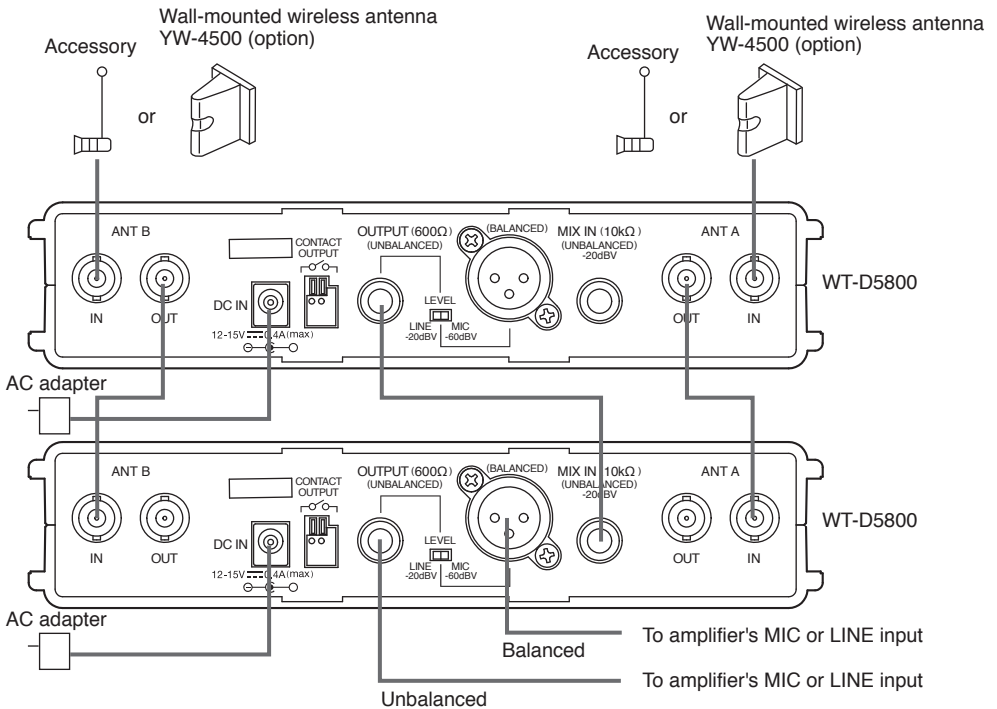

7.3. Contact Output Settings

The WT-D5800 unit features no-voltage output contacts, which can be used to control external equipment, such as system PA amplifiers.

[Operation trigger (TRIGGER)]

Two types of operation triggers are available for starting and stopping contact outputs: Reception Status (RF ON) and Remaining Battery Capacity Warning (BATT ALARM).

Reception Status ("RF ON") (default setting):

The contact output is enabled when a signal is received normally (when microphone audio can be reproduced), and in other cases (when microphone audio cannot be reproduced) it is not enabled.

Remaining Battery Capacity Warning ("BATT ALARM"):

The contact output is enabled when the remaining battery capacity warning is activated (when the battery needs to be charged or replaced), and in other cases (when charging or replacement are not required) it is not enabled.

[Output type (TYPE)]

The contact has two types of output: Continuous Make ("LEVEL") and Pulse Make ("ONE-SHOT").

Continuous Make ("LEVEL") (default setting):

Signal is output immediately after the operation trigger is enabled, and signal output is stopped two seconds after the operation trigger is disabled.

Pulse Make ("ONE-SHOT"):

Signal is output immediately after the operation trigger is enabled, and signal output is stopped after one second has elapsed.

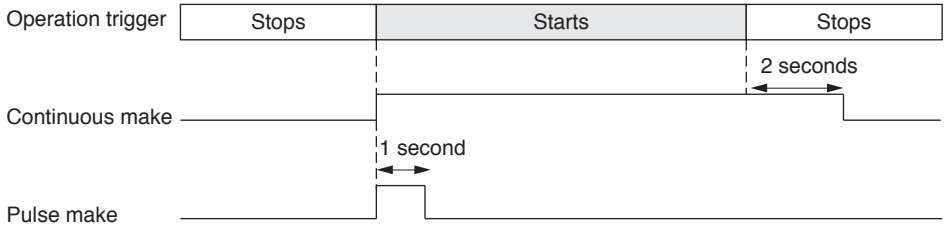

[Output control (ENABLE/DISABLE)]

"ON" or "OFF" can be selected for the output control of a contact ("ENABLE/DISABLE").

ON (default setting): Contact is output in response to an operation trigger.

OFF: Contact is not output, with no response to the operation trigger.

Tip

Setting contents are retained even if the power is switched OFF.

Notes

- When the operation trigger is set to "Remaining Battery Capacity Warning" mode, if the wireless microphone's power is switched off, the remaining battery capacity cannot be detected, resulting in the contact output being stopped.
- The contact output also stops in any of the following cases:
 - Channel scanning in progress.
 - Channel scanning and spectrum scanning by the supplied WT-D5800 Maintenance Software are in progress.

8. FUNCTION SETTINGS

Settings are performed in setting mode.

[Keys used in setting mode]

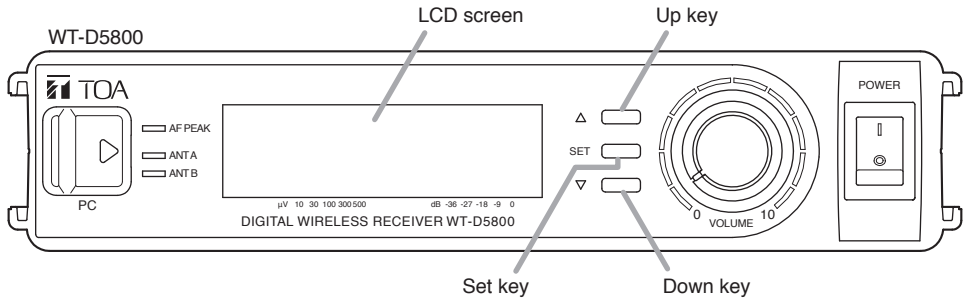

8.1. Placing the Unit in Setting Mode

Step: Press the Set key for about 1 second.
The unit is placed in setting mode.

The normal operating state

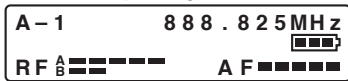

Pressed for about 1 second

Setting mode



8.2. Setting Items Displayed on the LCD Screen in Setting Mode

The display cycles through the indications "BANK," "CHANNEL," "ENCRYPTION," "CODE," "PAIRING," "FBS," "ANT ATTEN," "EQ PRESET," "CONTACT OUT," "CHANNEL SCAN," "LCD CONTRAST," "MODEL INFO" and "EXIT" with each depression of the Up key, or the Down key for the reverse action.

Notes

- The "CODE" indication is not displayed while the Encryption Function is enabled.
- The "PAIRING" indication is not displayed while the Encryption Function is disabled.

8.3. Function Settings

8.3.1. Bank number setting

Step 1. In setting mode, select the setting item "BANK" with the Up or Down key.

Step 2. Press the Set key, and the LCD screen displays the currently-set bank number and frequency with the prefix "√" indication. (Example: √ 7 805.000 MHz)

Step 3. Select the desired bank number with the Up or Down key.
The display cycles through the contents with each depression of the Up or Down key.

Note

When leaving the original bank number unchanged, select "EXIT" with Up or Down key and press the Set key. Then, the display returns to the "BANK" indication.

Step 4. Press the Set key to register the selected bank number.
This terminates the bank number setting, and the display returns to the "BANK" indication.

Step 5. When any other setting is not needed, select "EXIT" with the Up or Down key and press the Set key.
The unit returns to the normal operating state.

Note

When another setting is needed, select the necessary setting item with the Up or Down key and press the Set key.

8.3.2. Channel number setting

Step 1. In setting mode, select the setting item "CHANNEL" with the Up or Down key.

Step 2. Press the Set key, and the LCD screen displays the currently-set channel number and frequency with the prefix "√" indication. (Example: √ 8: 805.125 MHz)

Step 3. Select the desired channel number with the Up or Down key.
The display cycles through the contents with each depression of the Up or Down key.

Note

When leaving the original channel number unchanged, select "EXIT" with Up or Down key and press the Set key. Then, the display returns to the "CHANNEL" indication.

Step 4. Press the Set key to register the selected channel number.
This terminates the channel number setting, and the display returns to the "CHANNEL" indication.

Step 5. When any other setting is not needed, select "EXIT" with the Up or Down key and press the Set key.
The unit returns to the normal operating state.

Note

When another setting is needed, select the necessary setting item with the Up or Down key and press the Set key.

8.3.3. Encryption setting

This setting enables the Encryption Function, which prevents the contents of communications between the WT-D5800 unit and the microphone from being read externally.

Notes

- Complete the bank and channel settings for the WT-D5800 unit and the microphone before performing the encryption setting.
- Be sure to perform pairing setting (see p. 14) after the Encryption Function has been enabled. The Encryption Function will not work properly if the WT-D5800 and the microphone are not properly associated with each other by way of the pairing setting.

Step 1. In setting mode, select the setting item "ENCRYPTION" with the Up or Down key.

Step 2. Press the Set key, and the LCD screen displays the current setting.

Step 3. Select "ON" or "OFF" with the Up or Down key.

Note

When leaving the setting unchanged, select "EXIT" with Up or Down key and press the Set key. Then, the display returns to the "ENCRYPTION" indication.

Step 4. Press the Set key to register the setting.

This terminates the encryption setting, and the display returns to the "ENCRYPTION" indication.

Step 5. When any other setting is not needed, select "EXIT" with the Up or Down key and press the Set key.

The unit returns to the normal operating state.

Note

When another setting is needed, select the necessary setting item with the Up or Down key and press the Set key.

Tip

The lock icon is displayed on the LCD screen when the Encryption function is enabled.

8.3.4. Pairing setting

Perform pairing setting for the WT-D5800 unit and the microphone or transmitter only after the Encryption Function has been enabled.

Tips

- The symbol **M** means microphone operation, and **R** means receiver operation.
- The illustrations in this section show the WM-D5200.

- M Step 1.** With the battery compartment cover removed, switch ON the microphone power switch and confirm that the Encryption indicator is unlit. If the indicator is lit, switch encryption from ON to OFF (see p. 16).

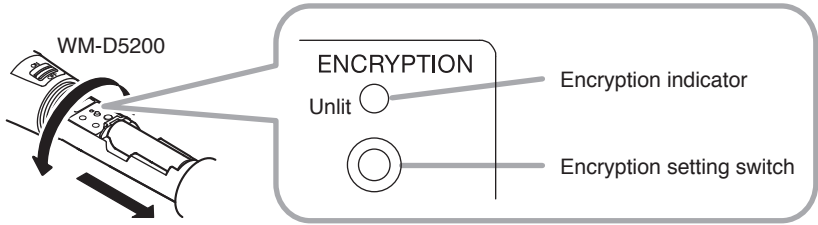

- M Step 2.** Switch OFF the microphone power switch.

- R Step 3.** In setting mode, select the setting item "PAIRING" with the Up or Down key.

Note

The "PAIRING" indication is not displayed while the Encryption Function is disabled, making it impossible to perform the pairing setting.

- R Step 4.** Press the Set key, and the LCD screen displays the "HOLD THE SET KEY" indication.

- M Step 5.** Switch ON the microphone power switch while holding down the microphone's Encryption setting switch (continue holding until **Step 7**). Confirm that the microphone's Encryption indicator is flashing. An ID number is transmitted while the microphone's Encryption setting switch is held down.

- R Step 6.** Hold down the Set key to start pairing. The "RECEIVING" indication is displayed on the LCD screen during pairing.

Tip

To interrupt the pairing setting, release the Set key.



- M Step 7.** After confirming that the WT-D5800's LCD display has switched to the "SUCCESS" indication, release the microphone's Encryption setting switch.

WT-D5800's LCD screen



- R Step 8.** Release the Set key.
The LCD display returns to the "EXIT" indication.

- M Step 9.** Confirm that the microphone's Encryption indicator is lit.
The encryption setting is now ON.

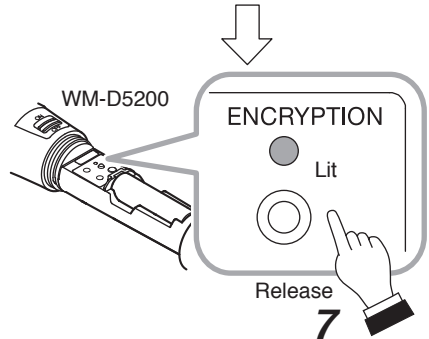

- M Step 10.** Switch off the microphone.

- R Step 11.** Press the Set key. Then, the display returns to the "PAIRING" indication.

- Step 12.** When any other setting is not needed, select "EXIT" with the Up or Down key and press the Set key.
The unit returns to the normal operating state.

R

Note

When another setting is needed, select the necessary setting item with the Up or Down key and press the Set key.

Notes

- Do not switch OFF the power to the microphone or receiver during setting.
- Hold down the microphone's Encryption setting switch and the receiver's Set key until the "SUCCESS" indication appears on the receiver's LCD screen.
If the microphone's Encryption setting switch or the receiver's Set key is released while the "RECEIVING" indication is displayed on the receiver's screen, the receiver will not have correctly received the new ID number, leaving the ID number unchanged from the previous value. To match the receiver ID number with the microphone ID number, switch OFF the microphone's encryption setting, then repeat **Steps 1 – 11** above.

Tips

- The ID number is updated when the encryption is switched from OFF to ON again. (The encryption ON/OFF status and ID number are retained even if the power switch is switched OFF.)
- Settings can be performed regardless of whether the microphone or receiver Encryption setting switch was depressed first.
- The receiver does not output audio during ID number setting, even if it receives a radio signal from the microphone.

M [Switching the Microphone Encryption function from ON to OFF]

Step 1. With the battery compartment cover removed, switch ON the microphone power switch and confirm that the Encryption indicator is lit.

Step 2. Switch OFF the power switch.

Step 3. Switch ON the microphone power switch while holding down the Encryption setting switch.

Note

Do not switch OFF the microphone power switch during setting.

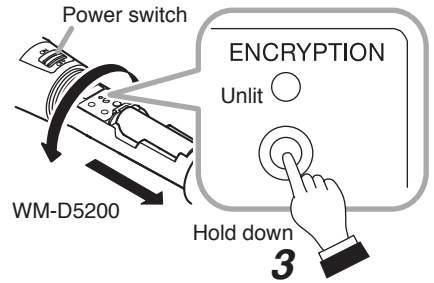

Step 4. Confirm that the Encryption indicator has extinguished, then release the Encryption setting switch.
The encryption setting switches to OFF.

8.3.5. Code setting

Perform code setting by selecting a code from among 10 different numbers. Only the audio of the microphone assigned with the same code as the WT-D5800 unit can be output.

Notes

- Complete the bank and channel settings for the WT-D5800 unit and the microphone before performing the code setting.
- Enabling the Encryption Function after completion of the code setting will invalidate the code setting.

Step 1. In setting mode, select the setting item "CODE" with the Up or Down key.

Note

The "CODE" indication is not displayed while the Encryption Function is enabled, making it impossible to set the code.

Step 2. Press the Set key, and the LCD screen displays the current setting.

Step 3. Select the desired code number with the Up or Down key.

The display cycles through the contents with each depression of the Up or Down key.

Note

When leaving the original code number unchanged, select "EXIT" with Up or Down key and press the Set key. Then, the display returns to the "CODE" indication.

Step 4. Press the Set key to register the setting.

This terminates the code setting, and the display returns to the "CODE" indication.

Step 5. When any other setting is not needed, select "EXIT" with the Up or Down key and press the Set key.

The unit returns to the normal operating state.

Note

When another setting is needed, select the necessary setting item with the Up or Down key and press the Set key.

8.3.6. Feedback suppressor (FBS) setting

Acoustic feedback can be automatically suppressed.

Step 1. In setting mode, select the setting item "FBS" with the Up or Down key.

Step 2. Press the Set key, and the LCD screen displays the current setting.

Step 3. Select "ON" or "OFF" with the Up or Down key.

Note

When leaving the setting unchanged, select "EXIT" with Up or Down key and press the Set key. Then, the display returns to the "FBS" indication.

Step 4. Press the Set key to register the setting.

This terminates the FBS setting, and the display returns to the "FBS" indication.

Step 5. When any other setting is not needed, select "EXIT" with the Up or Down key and press the Set key.

The unit returns to the normal operating state.

Note

When another setting is needed, select the necessary setting item with the Up or Down key and press the Set key.

Tip

The FBS indication is displayed on the LCD screen when the FBS function is enabled.

8.3.7. Antenna attenuator (ANT ATTEN) setting

This setting reduces radio interference by attenuating the signal to the antenna input terminal by 10 dB.

Step 1. In setting mode, select the setting item "ANT ATTEN" with the Up or Down key.

Step 2. Press the Set key, and the LCD screen displays the "ANT A" indication.

Step 3. Select "ANT A" or "ANT B" with the Up or Down key.

Note

When leaving the original ANT ATTEN setting unchanged, select "EXIT" with Up or Down key and press the Set key. Then, the display returns to the "ANT ATTEN" indication.

Step 4. Press the Set key.

Step 5. Select "0 dB" or "-10 dB" with the Up or Down key.

Step 6. Press the Set key to register the setting.

Step 7. Repeat **Steps 3 – 6** to perform the setting for another antenna input.

Step 8. When any other setting is not needed, select "EXIT" with the Up or Down key and press the Set key.

The unit returns to the normal operating state.

Note

When another setting is needed, select the necessary setting item with the Up or Down key and press the Set key.

8.3.8. EQ setting

This setting permits adjustment of the WT-D5800 unit's audio output for a more easily heard sound quality. (Default setting: OFF)

Step 1. In setting mode, select the setting item "EQ PRESET" with the Up or Down key.

Step 2. Press the Set key, and the LCD screen displays the current setting.

Step 3. Select the desired EQ setting with the Up or Down key.

The display cycles through the contents with each depression of the Up or Down key.

Note

When leaving the original EQ setting unchanged, select "EXIT" with Up or Down key and press the Set key. Then, the display returns to the "EQ PRESET" indication.

Tip

EQ setting selections are shown for each microphone model number.

Step 4. Press the Set key to register the setting.

This terminates the EQ setting, and the display returns to the "EQ PRESET" indication.

Step 5. When any other setting is not needed, select "EXIT" with the Up or Down key and press the Set key.

The unit returns to the normal operating state.

Note

When another setting is needed, select the necessary setting item with the Up or Down key and press the Set key.

8.3.9. Contact out setting

Make contacts can be provided from the WT-D5800 unit depending on the microphone status. See p. 10 for details regarding each setting.

Step 1. In setting mode, select the setting item "CONTACT OUT" with the Up or Down key.

Step 2. Perform ENABLE/DISABLE setting.

2-1. Press the Set key, and the LCD screen displays the "ENABLE/DISABLE" indication.

Note

When leaving the original CONTACT OUT setting unchanged, select "EXIT" with Up or Down key and press the Set key. Then, the display returns to the "CONTACT OUT" indication.

2-2. Press the Set key, and the LCD screen displays the current setting.

2-3. Select "ON" or "OFF" with the Up or Down key.

2-4. Press the Set key to register the setting.

This terminates the ENABLE/DISABLE setting, and the display returns to the "ENABLE/DISABLE" indication.

Note

When leaving the original ENABLE setting unchanged, select "EXIT" with Up or Down key and press the Set key. Then, the display returns to the "ENABLE/DISABLE" indication.

Step 3. Perform TYPE setting.

3-1. Select "TYPE" with the Up or Down key.

3-2. Press the Set key, and the LCD screen displays the current setting.

3-3. Select "LEVEL" or "ONE-SHOT" with the Up or Down key.

3-4. Press the Set key to register the setting.

This terminates the TYPE setting, and the display returns to the "TYPE" indication.

Note

When leaving the original TYPE setting unchanged, select "EXIT" with Up or Down key and press the Set key. Then, the display returns to the "TYPE" indication.

Step 4. Perform TRIGGER setting.

4-1. Select "TRIGGER" with the Up or Down key.

4-2. Press the Set key, and the LCD screen displays the current setting.

4-3. Select "RF ON" or "BATT ALARM" with the Up or Down key.

4-4. Press the Set key to register the setting.

This terminates the TRIGGER setting, and the display returns to the "TRIGGER" indication.

Note

When leaving the original TRIGGER setting unchanged, select "EXIT" with Up or Down key and press the Set key. Then, the display returns to the "TRIGGER" indication.

Step 5. Select "EXIT" with the Up or Down key and press the Set key.
The display returns to the "CONTACT OUT" indication.

Step 6. When any other setting is not needed, select "EXIT" with the Up or Down key and press the Set key.

The unit returns to the normal operating state.

Note

When another setting is needed, select the necessary setting item with the Up or Down key and press the Set key.

8.3.10. Bank and channel detection

Idle frequencies are automatically scanned and usable frequencies are displayed.

Step 1. In setting mode, select the setting item "CHANNEL SCAN" with the Up or Down key.

Step 2. Press the Set key, and the LCD screen displays the "START" indication.

Step 3. Press the Set key to start bank and channel detection.

Bank and channel detection begins, and an idle bank and channel number is displayed on the bank selection screen.

On the bank selection screen, idle frequencies are displayed by bank number and channel number for each bank number.

If no idle channel is detected, "NO VACANT CHANNEL" is displayed.

Tips

- The "CHANNEL SCANNING" indication is displayed on the LCD screen during channel scanning.
- Pressing the Set key while channel scanning is in progress stops the channel scan and causes the partial scan results to be displayed.
In this event, the "NO VACANT CHANNEL" indication is displayed for unscanned banks.

Step 4. Select the desired bank number with the Up or Down key and press the Set key.
The channel number setting screen will appear.

Note

When leaving the original bank and channel setting unchanged, select "EXIT" with Up or Down key and press the Set key. Then, the display returns to the "CHANNEL SCAN" indication.

Step 5. Select the desired channel number with the Up or Down key and press the Set key.
This terminates the bank and channel detection, and the display returns to the "CHANNEL SCAN" indication.

Note

When setting the channel numbers for other bank numbers, select "EXIT" to return the display to the bank selection screen.

Step 6. When any other setting is not needed, select "EXIT" with the Up or Down key and press the Set key.
The unit returns to the normal operating state.

Note

When another setting is needed, select the necessary setting item with the Up or Down key and press the Set key.

8.3.11. LCD contrast adjustment setting

This setting adjusts the WT-D5800 unit's LCD screen contrast.

- Step 1.** In setting mode, select the setting item "LCD CONTRAST" with the Up or Down key.
- Step 2.** Press the Set key, and the currently-set contrast adjustment display appears on the LCD screen.
- Step 3.** Select the desired contrast level with the Up or Down key.
- Step 4.** Press the Set key to register the selected contrast level.
This terminates the contrast setting, and the display returns to the "LCD CONTRAST" indication.
- Step 5.** When any other setting is not needed, select "EXIT" with the Up or Down key and press the Set key.
The unit returns to the normal operating state.

Note

When another setting is needed, select the necessary setting item with the Up or Down key and press the Set key.

8.3.12. Confirming firmware version

Confirm the WT-D5800 unit's firmware version number.

- Step 1.** In setting mode, select the setting item "MODEL INFO" with the Up or Down key.
- Step 2.** Press the Set key to display the firmware version.
- Step 3.** Press the Set key again to exit the firmware display mode, and the display returns to the "MODEL INFO" indication.
- Step 4.** When any other setting is not needed, select "EXIT" with the Up or Down key and press the Set key.
The unit returns to the normal operating state.

Note

When another setting is needed, select the necessary setting item with the Up or Down key and press the Set key.

9. OPERATION

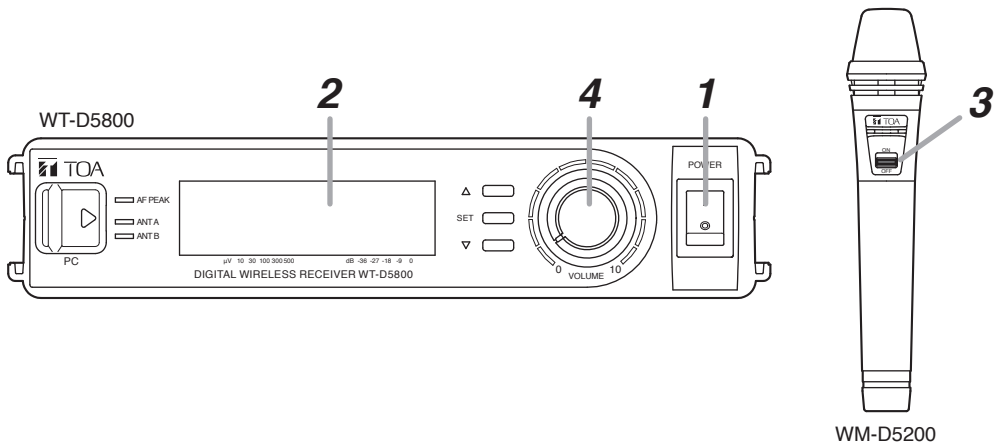

- Step 1.** Turn the power on.
The LCD screen comes to display the receiving frequency and RF/AF levels.
- Step 2.** Confirm that the wireless microphone and this unit are identical in the bank and channel number.
- Step 3.** Set the wireless microphone power switch to the ON position.
The reception indicator lights green when the receiver receives the same frequency signal.
- Step 4.** Adjust the volume control.
The output level increases as the control is rotated clockwise, and decreases as rotated counterclockwise.
- Tip**
The knob is initially set at the two o'clock position, thus make adjustment to the desired volume. When the AF peak indicator is lit at all times, lower the volume.
- Step 5.** After the usage of the unit, turn OFF the power and the wireless microphone power switch.

Note

Depending on the setting of the contact output, when you set the wireless microphone power switch to ON, there is the case that the external device connected to the unit may be operational with the contact output from the unit.

10. HOW TO CHECK AND DEAL WITH INTERFERENCE

[Order of Actions (Action Flowchart)]

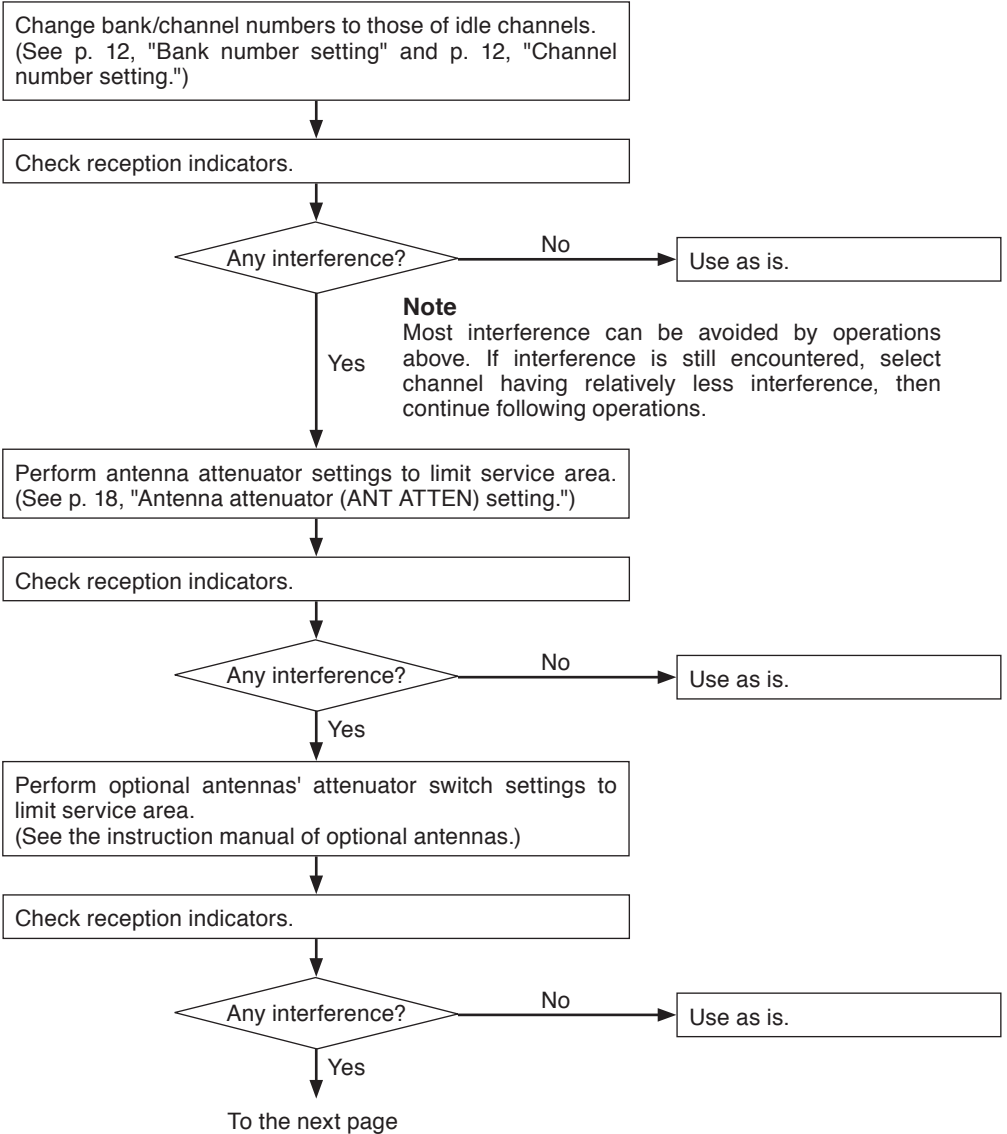

From the previous page

Perform microphone's or transmitter's Transmission output changeover switch settings to limit service area.
(See the instruction manual of optional microphone or transmitter.)

Check reception indicators.

Any interference?

No

Use as is.

Yes

Is the encryption function set to "ON"?

No

Perform code setting.
(See p. 17, "Code setting.")

Yes

Perform pairing setting. (See p. 14, "Pairing setting.")

Check reception indicators.

Any interference?

No

Use as is.

Yes

When radio interference is still encountered, consult shop from where unit was purchased.

11. SPECIFICATIONS

Version	WT-D5800 EC4, WT-D5800 EC7	WT-D5800 EG1, WT-D5800 GG1, WT-D5800 -G1
Power Source	AC mains (supplied AC adapter must be used)	
Current Consumption	350 mA (13.5 V)	
Receiving Frequency	794 – 832 MHz (794 – 806 MHz for Thailand)	606 – 636 MHz
Channel Selectable	160 selectable frequencies	
Receiving System	Double super-heterodyne	
Diversity system	Space diversity (digital diversity)	
Mixing Output	MIC/LINE (selectable): –60 dB* (MIC)/–20 dB* (LINE), 600 Ω phone jack (unbalanced), 600 Ω XLR-3-32 type connector (balanced)	
Mixing Input	–20 dB*, 10 kΩ, unbalanced, phone jack	
Antenna Input	75 Ω, BNC (phantom powering for antenna), 9 V DC, 30 mA (max)	
Antenna Output	75 Ω, BNC (Gain 0 dB)	
Contact Output	1 channel, no-voltage make contact output, withstand voltage: 30 V DC, control current 0.5 A max terminal block (2 pins)	
Receiving Sensitivity	24 dBμV or less (Bit error rate: 1E-5 or less)	
Antenna Input Attenuator	0 dB/–10 dB switchable	
Indicator	Audio (5 steps), RF (5 steps), ANT A/B, Audio (peak), Battery alarm	
Frequency Response	50 Hz – 12 kHz	
Total Harmonic Distortion	0.5 % or less	
Function	Frequencies scanning, Feedback suppressor, Equalizer (optimizing each compatible microphone)	
ID Selectable	10 patterns	
Operating Temperature	–10 to +50 °C (14 to 122 °F)	
Operating Humidity	30 to 85 %RH (no condensation)	
Finish	Resin, black	
Dimensions	210 (w) × 44 (h) × 211.9 (d) mm (8.27" × 1.73" × 8.34")	
Weight	730 g (1.61 lb)	

* 0 dB = 1V

Note: The design and specifications are subject to change without notice for improvement.

• Accessories

[WT-D5800 EC4, WT-D5800 EC7, WT-D5800 EG1, WT-D5800 GG1]	
AC adapter	1
Whip antenna	2
Rubber foot	4

[WT-D5800 -G1]	
Whip antenna	2
Rubber foot	4

Note: As for the usable AC adapter, consult your TOA dealer.

• Optional products

Rack mounting bracket kit: MB-WT3 (for rack mounting one WT-D5800 unit)
MB-WT4 (for rack mounting two WT-D5800 units)

Note

The WT-D5800 cannot communicate with the TRANTEC Wireless System (S4 and S5 Series) nor with the TOA Analog Wireless System (WM-5325, WM-5225 etc.).



DECLARATION OF CONFORMITY

We: TOA Electronics Europe GmbH
Süderstraße 282, 20537 Hamburg, Germany

as the authorised representative of the

Manufacturer: TOA Corporation
7-2-1, Minatojima-nakamachi, Chuo-ku, Kobe, Japan 650-0046

declare, under our sole responsibility, that the product

Product Name: **DIGITAL WIRELESS RECEIVER**

Model Number: **WT-D5800**

conforms with following specifications:

EMC: ETSI EN 301 489-1: V1.9.2 (2011-09),
ETSI EN 301 489-9: V1.4.1 (2007-11)

ERM: ETSI EN 300 422-2: V1.4.1 (2015-06)

LVD : EN 60950-1: 2006 + A11: 2009 + A1: 2010 + A12: 2011 + A2: 2013

RoHS: EN 50581: 2012

The product herewith complies with the requirements of the EU directives:
2011/65/EU relating to the restrictions of hazardous substances (RoHS),
1999/5/EC relating to the spectrum (ERM, EMC, LVD, Health).



Hamburg, 29th November 2016
(place, date)



T. Sakata, Managing Director
(authorised signature)

The Technical Construction File (TCF) is kept at the UK office:

TOA Corporation (UK) Ltd; Unit 7 & 8, The Axis Centre, Cleeve Road, Leatherhead, Surrey, KT22
7RD, United Kingdom
Tel.: +44 (0) 870 774 0987; Fax: +44 (0) 870 777 0839; URL: www.toa.co.uk

German Office:

TOA Electronics Europe GmbH, Süderstraße 282, 20537 Hamburg, Germany
Tel: +49 / (0)40 / 25 17 19-0, Fax: +49 / (0)40 / 25 17 19-98 URL: www.toa.eu

COMPLIANCE STATEMENT TO WT-D5800

AT DE	Österreich Deutschland	Hiermit erklärt TOA Electronics Europe GmbH die Übereinstimmung des Empfängers / Empfangsmoduls mit den grundlegenden Anforderungen und den anderen relevanten Festlegungen der Richtlinie 1999/5/EG.
BE	België	Bij deze verklaart TOA Electronics Europe GmbH dat deze ontvanger / ontvangstmodule voldoet aan de essentiële eisen en aan de overige relevante bepalingen van Richtlijn 1999/5/EC.
	Belgique	Par la présente, TOA Electronics Europe GmbH déclare que ce récepteur / module de réception est conforme aux exigences essentielles et aux autres dispositions de la directive 1999/5/CE qui lui sont applicables.
CH	Schweiz	Hiermit erklärt TOA Electronics Europe GmbH, dass sich dieser Empfänger / dieses Empfangsmodul in Übereinstimmung mit den grundlegenden Anforderungen und den anderen relevanten Vorschriften der Richtlinie 1999/5/EG befinden. (CH: Telion AG, URL: www.telion.ch)
DK	Danmark	Undertegnede TOA Electronics Europe GmbH erklærer herved, at følgende udstyr Modtager / Modtager Modul overholder de væsentlige krav og øvrige relevante krav i direktiv 1999/5/EF.
ES	España	TOA Electronics Europe GmbH declara que el receptor / sintonizador inalámbrico cumple con los requisitos esenciales y otras disposiciones aplicables o exigibles en la Directiva 1999/5/CE.
FI	Suomi / Finland	TOA Electronics Europe GmbH vakuuttaa täten että tämä vastaanotin / viritinmoduli on direktiivin 1999/5/EY oleellisten vaatimusten ja sitä koskevien direktiivin muiden ehtojen mukainen.
FR CH	France Suisse	Par la présente TOA Electronics Europe GmbH déclare que l'appareil récepteur / module de réception est conforme aux exigences essentielles et aux autres dispositions pertinentes de la directive 1999/5/CE. (CH : Telion AG, URL : www.telion.ch)
GB	Great Britain	Hereby, TOA Electronics Europe GmbH, declares that this receiver / tuner module is in compliance with the essential requirements and other relevant provisions of Directive 1999/5/EC.
GR	Ελλάδα	Με την παρούσα η εταιρεία TOA Electronics Europe GmbH δηλώνει ότι ο ραδιοφωνικός δέκτης / μονάδα δέκτη συμμορφώνεται με τις ουσιαστικές απαιτήσεις και τις λοιπές σχετικές διατάξεις της οδηγίας 1995/5/ΕΚ.
IT CH	Italia Svizzera	Con la presente TOA Electronics Europe GmbH dichiara che questo Ricevitore / Modulo sintonizzatore è conforme ai requisiti essenziali ed alle altre disposizioni pertinenti stabilite dalla direttiva 1999/5/CE. (CH: Telion AG, URL:www.telion.ch)
NL	Nederland	Hierbij verklaart TOA Electronics Europe GmbH dat deze ontvanger / ontvangstmodule in overeenstemming is met de essentiële eisen en de andere relevante bepalingen van richtlijn 1999/5/EG.

NO	Norway	TOA Electronics Europe GmbH erklærer herved, at denne mottagermodul / radio er i samsvar med de vesentlige egenskaperne og øvrige relevante krav i direktiv 1999/5/EC. (N: Scandec Systemer AS, URL: www.scandecsystemer.no)
PT	Portugal	TOA Electronics Europe GmbH declara que este Receptor / Sintonizador está conforme com os requisitos essenciais e outras disposições da Directiva 1999/5/CE.
SE	Sverige	Härmed intygar TOA Electronics Europe GmbH att denna Mottagare / Radiomodul står i överensstämmelse med de väsentliga egenskapskrav och övriga relevanta bestämmelser som framgår av direktiv 1999/5/EG.

INTENDED USE OF WT-D5800

<p style="text-align: center;">AT CH D</p>	<p>Österreich Schweiz Deutschland</p>	<p style="text-align: center;">WICHTIGER HINWEIS !</p>	<p>Der Gebrauch dieses Funkempfängers für andere Zwecke als zum Empfang eines Tonsignals von einem passenden Funkmikrofon ist nicht zulässig.</p> <p>Dieses Gerät arbeitet auf in der europäischen Gemeinschaft (EU) nicht harmonisierten Frequenzen. Abhängig vom geografischen Gebiet dürfen bestimmte Frequenzen legal mit oder ohne Autorisierung / individueller Lizenz entsprechend der beigefügten Frequenztafel genutzt werden.</p>
<p style="text-align: center;">B NL</p>	<p>België Nederland</p>	<p style="text-align: center;">BELANGRIJKE AANWIJZING !</p>	<p>Het is niet toegestaan deze ontvanger te gebruiken voor enig ander doel dan het ontvangen van een audiosignaal van de bijbehorende draadloze microfoon.</p> <p>Dit apparaat maakt gebruik van frekwentiebanden welke in de Europese Gemeenschap (EG) niet algemeen zijn toegestaan. Afhankelijk van de geografische ligging kan voor het legaal gebruik van een bepaalde frekwentie een vergunning nodig zijn, zoals is aangegeven in de frekwentietabel.</p>
<p style="text-align: center;">B CH F</p>	<p>Belgique Suisse France</p>	<p style="text-align: center;">AVIS IMPORTANT !</p>	<p>Ne pas utiliser les récepteurs HF pour une réception du signal audio provenant d'un appareil, autre que les microphones prévus à cet effet.</p> <p>Cet appareil utilise des fréquences d'émission qui ne sont pas harmonisées à travers la Communauté Européenne (EU). En fonction du lieu géographique certaines fréquences peuvent être utilisées de façon légale avec ou sans autorisation / licence individuelle comme décrit dans le tableau des fréquences.</p>
<p style="text-align: center;">DK</p>	<p>Danmark</p>	<p style="text-align: center;">VIGTIGT !</p>	<p>Det er ulovligt at bruge denne modtager til andre formål end at modtage et lydssignal fra en passende trådløs mikrofon.</p> <p>Dette udstyr anvender frekvens bånd, som ikke er harmoniseret i EU. Afhængigt af det enkelte land/område kan bestemte frekvenser anvendes lovligt med eller uden individuel licens som beskrevet i frekvens tabellen.</p>

EL	Ελλάδα	ΣΗΜΑΝΤΙΚΗ ΣΗΜΕΙΩΣΗ !	<p>Είναι παράνομη η χρήση του δέκτη για οποιοδήποτε άλλο λόγο εκτός της λήψης ηχητικού σήματος από το αντίστοιχο ασύρματο μικρόφωνο.</p> <p>Η συσκευή αυτή χρησιμοποιεί συχνότητες οι οποίες δεν εναρμονίζονται σε όλη την Ευρωπαϊκή Ένωση (Ε.Ε.). Ανάλογα με τη γεωγραφική περιοχή συγκεκριμένες συχνότητες μπορούν να χρησιμοποιηθούν νόμιμα με ή χωρίς άδεια / ειδική άδεια όπως αναφέρεται στον πίνακα συχνοτήτων.</p>
ES	España	¡ AVISO IMPORTANTE !	<p>Es ilegal utilizar este receptor para cualquier otro propósito que no sea recibir una señal de audio de su correspondiente micrófono inalámbrico.</p> <p>Este dispositivo hace uso de bandas de frecuencia que no son legales en toda la Comunidad Europea (CE). Dependiendo del área geográfica, ciertas frecuencias se pueden utilizar legalmente, con o sin autorización individual, según se indica en la tabla de frecuencias.</p>
FI	Suomi / Finland	HUOMIOITAVAA !	<p>Tätä vastaanotinta saa käyttää ainoas- taan audiosignaalien vastaanottamiseen sille tarkoitelta langattomalta mikrofoni- lta.</p> <p>Tämä laite käyttää taajuuksia jotka eivät ole yhteneviä koko EU:n alueella. Riippuen maantieteelliestä sijainnista joitain taajuuksia saa käyttää joko radio- luvan kanssa tai ilman. Ks. oheinen taajuustaulukko.</p>
I CH	Italia Svizzera	AVVISO IMPORTANTE !	<p>È illegale utilizzare questo ricevitore per qualsiasi altro scopo che non sia la ricezione di un segnale audio dal suo radiomicrofono.</p> <p>Questo prodotto utilizza bande di frequenza che non sono totalmente armonizzate in tutta la Comunità Europea (EU). Dipendentemente dall'area certe aree geografica certe frequenze possono essere usate legalmente con o senza autorizzazione / licenze individuali come stabilito nella tabella delle frequenze.</p>

N	Norway	VIKTIG MELDING !	<p>Det er ulovlig å bruke denne mottakeren til noe annet formål enn å motta et lydsignal fra en tilhørende trådløs mikrofon.</p> <p>Denne enheten gjør bruk av frekvensbånd som ikke gjennomført er harmonisert i det Europeiske Fellesskap (EU). Avhengig av det geografiske område kan noen frekvenser være tillatt brukt med eller uten autorisasjon / individuelle lisenser slik det er beskrevet i frekvenstabellen.</p>
P	Portugal	NOTA IMPORTANTE !	<p>Este Receptor só pode receber sinal de audio do respectivo Microfone Emissor.</p> <p>Este equipamento utiliza bandas de frequência que não estão harmonizadas em toda a Comunidade Europeia (CEE). De acordo com a área geográfica, certas frequências podem ser usadas com ou sem autorização / licença individual, conforme está mencionada na lista de frequências.</p>
S	Sverige	VIKTIG ANMÄRKNING !	<p>Det är illegalt att använda denna mottagare för något annat ändamål än att ta emot en audiosignal från dess tillhörande trådlösa mikrofon.</p> <p>Denna apparat utnyttjar frekvensband som inte överensstämmer med varandra inom hela Europeiska Gemenskapen (EG). Beroende på geografiskt område kan vissa frekvenser användas legalt med eller utan tillstånd/ individuell licens enligt frekvensplanen.</p>
UK	United Kingdom	IMPORTANT NOTICE !	<p>It is illegal to use this receiver for any other purpose than receiving an audio signal from its matching microphone.</p> <p>This device makes use of frequency bands which are not harmonised throughout the European Community (EU). Depending on the geographical area certain frequencies can be used legally with or without authorisation / individual license as stated in the frequency table.</p>

Traceability Information for Europe

Manufacturer:
TOA Corporation
7-2-1, Minatojima-Nakamachi, Chuo-ku, Kobe, Hyogo,
Japan

Authorized representative:
TOA Electronics Europe GmbH
Suederstrasse 282, 20537 Hamburg,
Germany