

DESCRIPTION

Integrated with a resin panel and speaker frame, the PC-658R is the ceiling mount speaker with a metal attached. It features spring clamp mechanism for easy speaker mounting to the ceiling. The input impedance can be easily changed by changing the tap position of the transformer.

SPECIFICATIONS

Rated Input	6 W (100 V line), 3 W (70 V line)
Rated Impedance	100 V line: 1.7 kΩ (6 W), 3.3 kΩ (3 W), 10 kΩ (1 W) 70 V line: 1.7 kΩ (3 W), 3.3 kΩ (1.5 W), 10 kΩ (0.5 W)
Sensitivity	90 dB (1 W, 1 m) (500 Hz - 5 kHz, pink noise)
Frequency Response	65 Hz - 18 kHz (peak -20 dB)
Speaker Component	16 cm (6") cone-type
Dimensions for Fixing Hole	Mounting hole: $\phi 170 \pm 5$ mm ($\phi 6.69" \pm 0.2"$) Ceiling thickness: 5 - 25 mm (0.2" - 0.98")
Speaker Mounting Method	Spring clamp
Finish	Baffle: Polypropylene resin, white (RAL 9016 equivalent) Grille: Surface-treated steel plate net, white (RAL 9016 equivalent), paint
Dimensions	$\phi 192 \times 73$ (D) mm ($\phi 7.56" \times 2.87"$)
Weight	500 g (1.1 lb)
Accessory	Paper pattern ...1

APPEARANCE

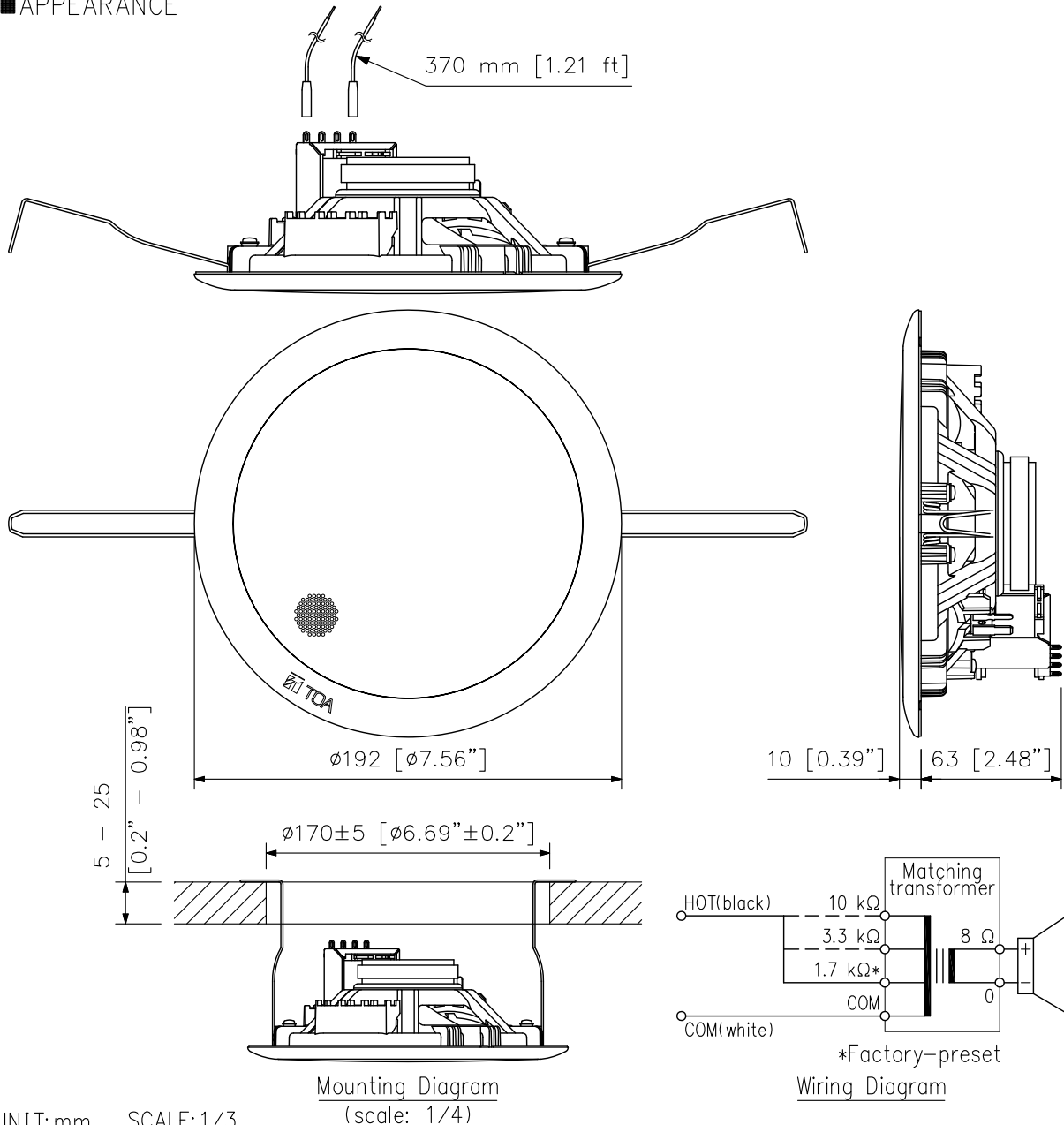

UNIT:mm SCALE:1/3